

MEASURING TABLES AND ADJUSTABLE SUPPORTS

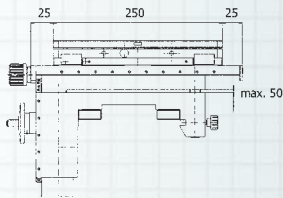

54-197-011

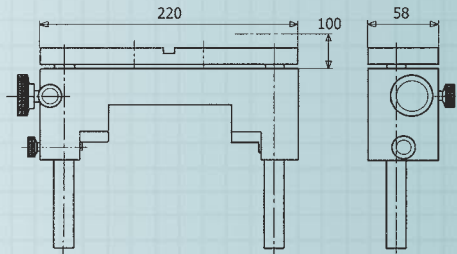
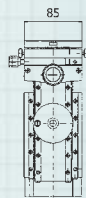

54-196-107

SUPPORTING/CLAMPING DEVICES FOR MEASURING TABLES AND SUPPORTS



54-196-021

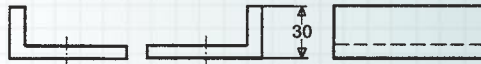

54-196-022

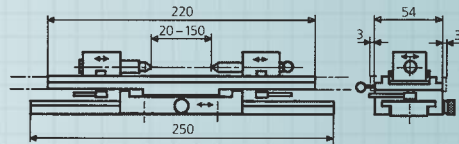
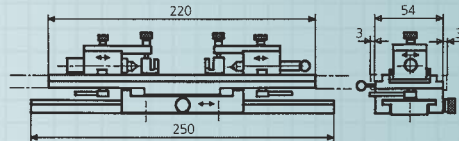

54-197-106



54-197-121

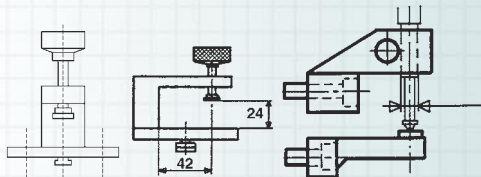

54-190-815



54-197-142

ACCESSORIES FOR EXTERNAL MEASUREMENTS

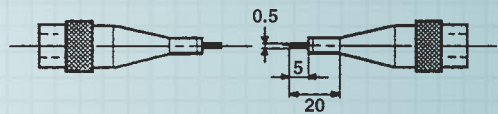

54-190-865

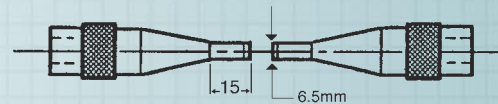

54-190-806 Ø6.5mm
54-197-806 Ø8mm



54-190-807





Trimos Labconcept Applications

ACCESSORIES FOR INTERNAL MEASUREMENTS

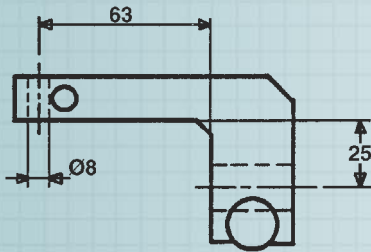
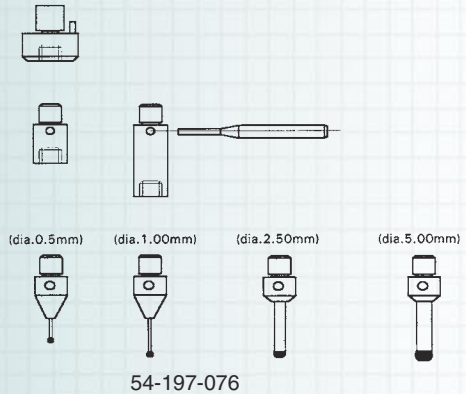
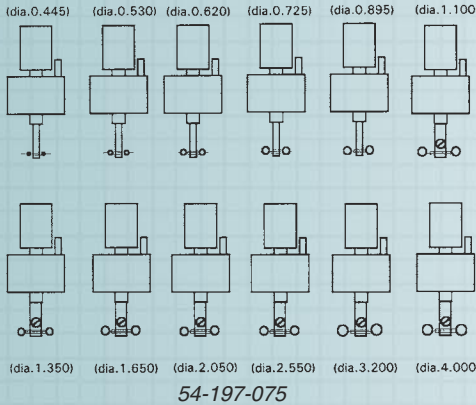

54-197-016

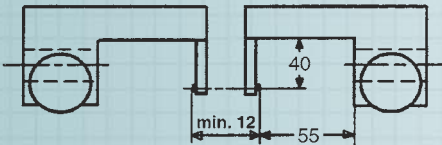

54-197-162

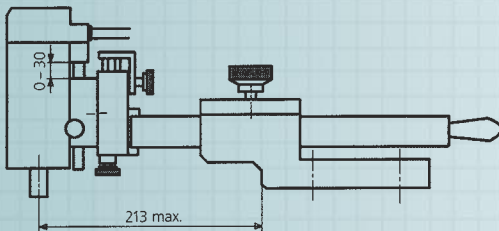

54-197-074

MASTER GAGES

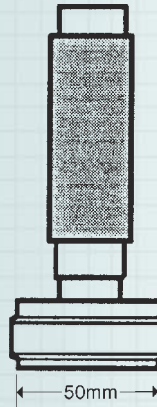

54-197-050

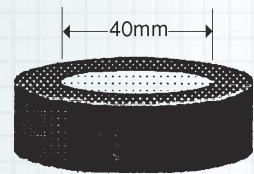

54-197-040

ACCESSORIES FOR SETTING AND CHECKING

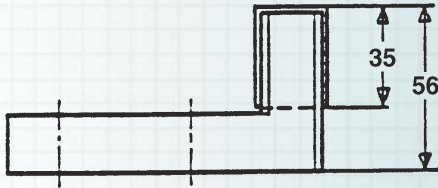

54-190-828 (25mm)
54-190-805 (1")

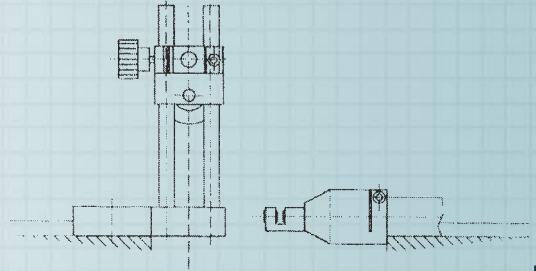

54-197-115

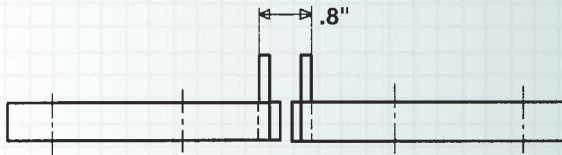

54-196-006

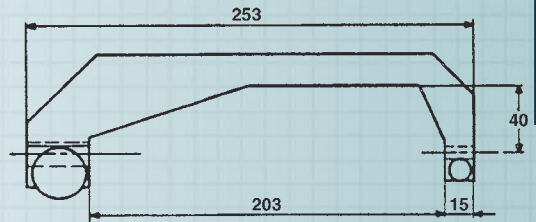

54-197-015

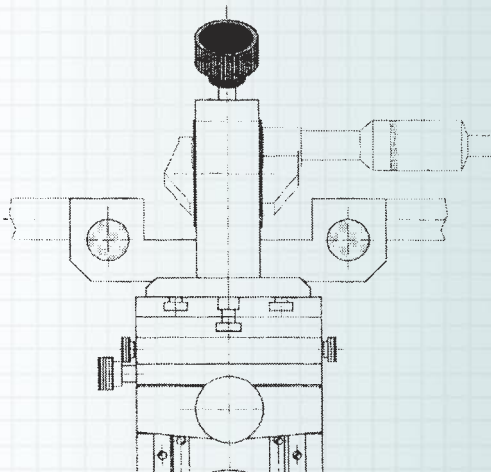

54-197-114

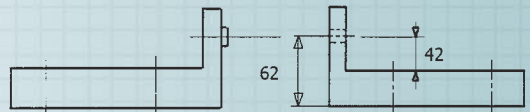

54-190-823

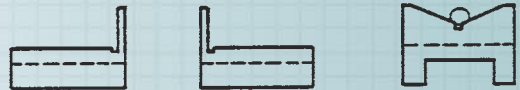

54-190-825



Trimos