

Fred V. Fowler Company, Inc.

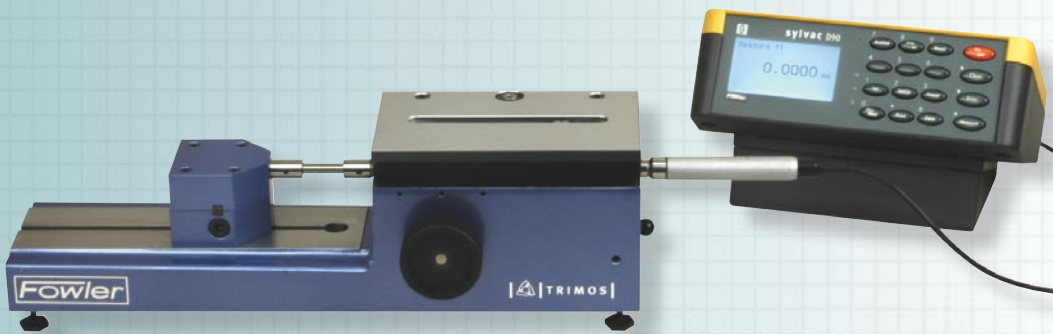

Trimos TELS Mini-Horizontal System



▲ Mini-Horizontal shown with optional Sylvac Display Unit No. 54-618-151 and probe No. 54-618-500 (not included).

The Fowler/Trimos Mini-Horizontal is a complete system for accurately measuring small internal and external sizes with a single gage.

Sylvac's electronic measuring system is recommended for use with the Mini-Horizontal because of its proven operational reliability. The display unit is the positive answer to a variety of measuring problems. In order to satisfy the demand of quality in production, a direct two-way RS232C data output allows connection to a printer or computer.

Using the multi-functional display unit D-100S (Fowler's 54-618-151) in connection with the Sylvac long travel probe 54-618-500, it is possible to obtain these basic functions.

Special Features:

- True inch/metric conversion with choice of 4 resolutions.
- Digital and analog display.
- Input of nominal sizes and tolerance limits.
- Classification (2 to 6 classes).
- Input of preselected values.
- Selection of measuring direction.
- Channel selection (1 to 64).
- Value hold.
- Locking of the functions and of inch or mm display.
- External contact connection (foot-pedal or computer).
- Print-out of all values/data processing.





Trimos TELS Mini-Horizontal System

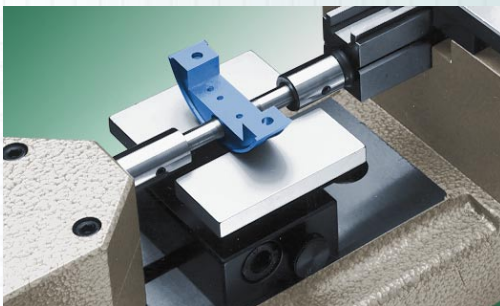
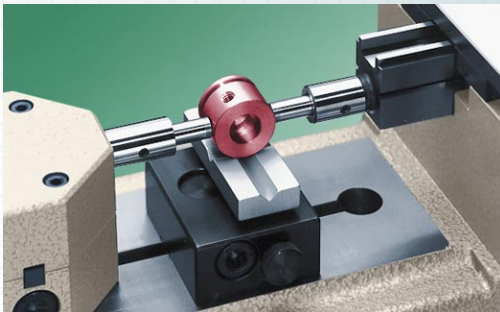
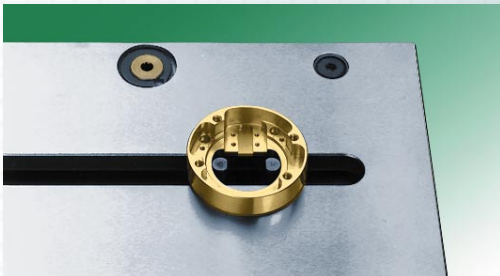

◆ Top two: Measurements of internal diameters, grooves and distances. Bottom two: Measurements of lengths and external diameters.

Internal measurements:

.24"—4" (6—100mm) depending on accessories used

External measurements:

0—4" (0—100mm). The effective measurement allows a range of 1" (25mm) which corresponds to the range of Sylvac probe No. 54-618-500.

External measuring range

is increased by displacing the end stop (direct zero setting or setting of a preselected value).

Internal measuring range

is increased by displacing the measuring inserts (setting of a preselected value according to a ring gage).

Accuracy:

Within .00006" (1.5 μ) — corresponds to accuracy of Sylvac probe No. 54-618-500.

Resolution:

Using Display Unit No. 54-618-140 or No. 54-618-151, the resolution is .0001" or .00001" (.001 or .0001mm).

Mini-Horizontal Construction:

- Monoblock construction with probe guide track.
- Adjustable end-stop with anvil location.
- Control knob for the displacement of the guide track of the monoblock (probe release).
- Adjustable measuring pressure device 3-8N.
- Location for different measuring features, i.e. electronic probes or indicators, 8mm diameter.
- Interchangeable measuring anvils for external measurements (53-190-019 anvils—6.5mm diameter with tungsten carbide tipped measuring surface are supplied as standard).
- Interchangeable measuring inserts for internal measurements (53-190-020 Inserts—4.5mm diameter, rounded, are supplied as standard).
- Vertically adjustable table for internal measurement, hard chromed and ground surface, supplied as standard.

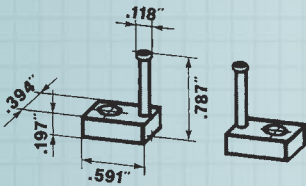
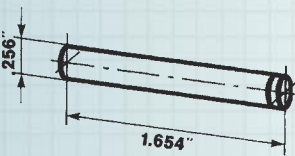
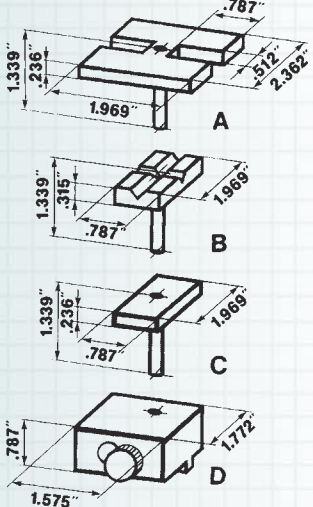
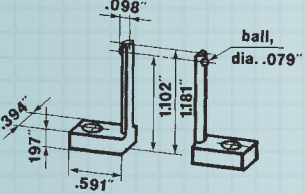
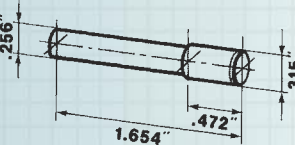
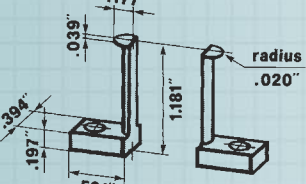
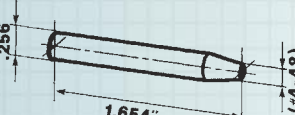
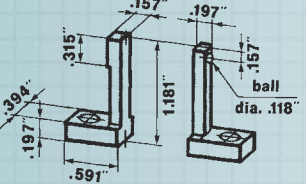
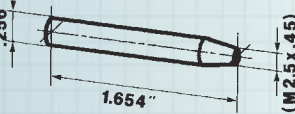
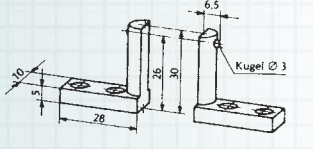

Internal Probes.	External Probes.	Supports & Tables.
 <p>▲ 53-190-020 Internal Probe Set (2 pc.) Standard, general purpose probes, included w/system.</p>	 <p>▲ 53-190-019 .256" diam. External Probe Set (2 pc.). Included with system. Carbide Tipped.</p>	 <p>▲ External Support System: A. #53-190-025 Adjustable Support with clearance. B. #53-190-026. Adjustable Support with crossed vee-grooves at 90° angles. C. #53-190-027. Adjustable Support Plate, plain. D. #53-190-028. Locking base w/vert. adjustment for #A, B & C. (Required in order to use #A, B & C).</p>
 <p>▲ 53-190-029 Internal Ball style Probe Set (2 pc.). Features .079" diam. ball on each probe.</p>	 <p>▲ 53-190-033 .315" Large Diameter External Probe Set. (2 pc.). Large surface, Carbide Tip.</p>	<p>▲ External Support System: A. #53-190-025 Adjustable Support with clearance. B. #53-190-026. Adjustable Support with crossed vee-grooves at 90° angles. C. #53-190-027. Adjustable Support Plate, plain. D. #53-190-028. Locking base w/vert. adjustment for #A, B & C. (Required in order to use #A, B & C).</p>
 <p>▲ 53-190-030 Internal Groove style Probe Set. (2 pc.). Features thin, half-round discs on ea. end.</p>	 <p>▲ 53-190-034 #4-48 threaded external contact point holder (Ea.). Accepts any shape point.</p>	<p>▲ External Support System: A. #53-190-025 Adjustable Support with clearance. B. #53-190-026. Adjustable Support with crossed vee-grooves at 90° angles. C. #53-190-027. Adjustable Support Plate, plain. D. #53-190-028. Locking base w/vert. adjustment for #A, B & C. (Required in order to use #A, B & C).</p>
 <p>▲ 53-190-031 Internal combination Ball & Flat Probe Set (2 pc.). Has one side ball, one side flat.</p>	 <p>▲ 53-190-032 M2.5 x .45 thread external contact point holder (Ea.). Accepts any shape point.</p>	 <p>▲ No. 53-190-036 Large ball probe. One set of reinforced measuring inserts with ball contact for internal measurements.</p>

Special anvils are available, contact our technical department.

Fred V. Fowler Company, Inc.



Trimos TELS Mini-Horizontal System

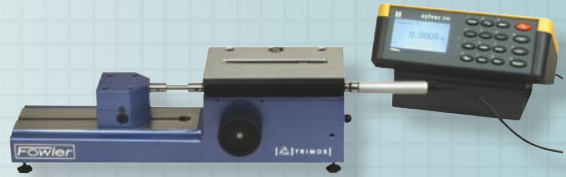
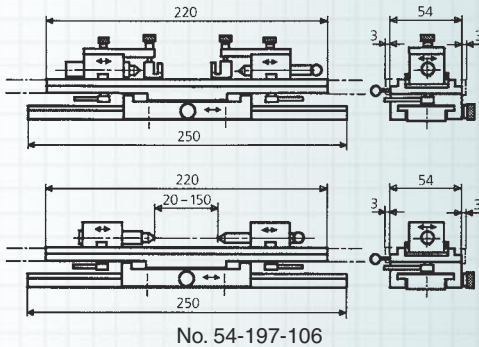

Order No.	Description
Mini-Horizontal:	
53-190-012	Mini-Horizontal with internal support plate, standard internal & external probes
Accessories:	
53-190-020	Std. replacement internal probe set (2 pc. Included w/unit)
53-190-029	Internal ball probe set. (2 pc.)
53-190-030	Internal groove probe set. (2 pc.)
53-190-031	Internal ball /flat probe set. (2 pc.)
53-190-036	Large ball probe. (2 pc.)
53-190-019	.256" std. replacement external probe set (2 pc. included w/unit)
53-190-033	.315" large diameter external probe set. (2 pc.)
53-190-034	No. 4-48 thread external contact point holder (each)
53-190-032	M2.5 x .45 thread external contact point holder (each)
53-190-037	.080" flat carbide probe (each)
53-190-025	Adjustable H support with clearance
53-190-026	Adjustable support with crossed V-grooves
53-190-027	Adjustable plain support plate, plane
53-190-028	Locking adjustable base w/vertical adjustment for above supports
54-197-106	Floating measuring table
Electronic Digital AGD Indicators:	
54-520-777	Ultra-Digit IV. 1" (25mm) x .00005" (.001mm)
54-520-888	Ultra-Digit V. 1" (25mm) x .00005" (.001mm) or .0005" (.01mm)
54-522-700	Ultra-Logic. 1" (25mm) x .0001" (.002mm)
54-522-800	Ultra-Logic. 1" (25mm) x .00005" (.001mm)
Bushings/Extensions:	
53-190-017	Bushing for all AGD indicators to Mini-Horizontal
53-190-018	Rack/extension for all AGD indicators to Mini-Horizontal
Sylvac Electronics:	
54-618-500	Sylvac probe: 1" (25mm) range
54-618-140	Sylvac D-80 Indication Unit
54-618-145	Sylvac D-90 Indication Unit
54-618-151	Sylvac D-100S Indication Unit