

## Manual

# LEVELMETER „LIGHT“

The easy to use display unit for

## MINILEVEL / LEVELTRONIC NT and ENGINEER SET TYPE 27 and ZEROTRONIC-SENSORS TYPE 3



**STRAIGHTNESS**  
GERADHEIT  
RECTITUDE



**PARALLELISM**  
PARALLELITÄT  
PARALLELISME

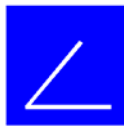

**INCLINATION**  
NEIGUNG  
INCLINAISON



**RECTANGULARITY**  
RECHTWINKLIGKEIT  
RECTANGULARITE



**FLATNESS**  
EBENHEIT  
PLANEITE

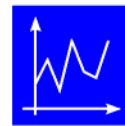

**MONITORING**  
ÜBERWACHUNG  
SURVEILLANCE



# CONTENT

<b>1.</b>	<b>INTRODUCTION</b>	<b>4</b>
1.1.	Principal description of the LEVELMETER „LIGHT“	4
1.2.	Possible configurations	5
A)	Set-up as display unit for individual or differential measurements (similar to the use of REMOTE DISPLAY)	5
B)	Using the LEVELMETER „LIGHT“ as an alternative to the LEVELMETER 2000 together with an Engineer set no. 27 respectively with a Leveladapter set	6
C)	Additional possible configurations	7
<b>2.</b>	<b>STARTING</b>	<b>8</b>
2.1.	Short description	8
<b>3.</b>	<b>HOW TO USE THE LEVELMETER „LIGHT“</b>	<b>9</b>
3.1.	Function check	9
3.2.	Data format	10
<b>4.</b>	<b>TECHNICAL DATA</b>	<b>10</b>
4.1.	Power supply	10
4.2.	Measuring range	10
4.3.	Resolution	10
4.4.	Various	10
<b>5.</b>	<b>REPAIR OF MEASURING INSTRUMENTS</b>	<b>11</b>

## Änderungen / Modifications:

Datum / Date	Geändert durch Modified by	Beschreibung der Änderung Description of modifications
10.1.2003	HEH/MO	Index included
2.4.2003	HEH	New:Express Repair Service

## INDEX

Key word		Chapter	Page
	<b>C</b>		
CLINOTRONIC PLUS		1.2	7
Connecting port „A“ for measuring instrument or power supply		2.1	8
Connecting port „B“ for reference instrument or power supply		2.1	8
Connecting possibilities of sensors and instruments		1.2	7
Connection RS232 for PC or power supply		2.1	8
	<b>D</b>		
Data format		3.2	10
Description of the LEVELMETER „LIGHT“		1.1	
	<b>E</b>		
Elements of the LCD display		3.1	9
Engineer set no. 27		1.2	6
Express Repair Service, ERS		5	11
	<b>F</b>		
Format of transmission		3.2	10
Function check		3.1	9
	<b>H</b>		
How to use the LEVELMETER „LIGHT“		3	9
	<b>I</b>		
INTRODUCTION		1	
	<b>L</b>		
LEVELMETER „LIGHT“ as an alternative to the LEVELMETER 2000 together with an Engineer set no. 27 respectively with a Leveladapter set		1.2	6
LEVELTRONIC NT		1.2	7
	<b>M</b>		
Main display		2.1	8
Measuring range		4.2	10
Measuring unit		2.1	8
MINILEVEL NT		1.2	7
	<b>P</b>		
Possible configurations		1.2	5
Power supply		4.1	10
	<b>R</b>		
Range		2.1	8
Repair of Measuring Instruments		5	11
Resolution		4.3	10
	<b>S</b>		
Set-up as display unit for individual or differential measurements (similar to the use of REMOTE DISPLAY)		1.2	5
Short description		2.1	8
Starting		2	8
	<b>T</b>		
Technical Data		4	10
Temperature range (storage)		4.4	10
	<b>Z</b>		
ZEROTRONIC sensors TYPE 3		1.2	7

## 1. INTRODUCTION

### 1.1. Principal description of the LEVELMETER „LIGHT“

The LEVELMETER „LIGHT“ was designed by WYLER AG, Switzerland as an alternative to the well proven LEVELMETER 2000 for use with

- the digital instrument family based on ZEROTRONIC technology
- the electronic inclination measuring instruments of the NT series (MINILEVEL & LEVELTRONIC) with digital measuring cell

**With the LEVELMETER „LIGHT“ all the sensors and instruments of the ZEROTRONIC and the "NT" family instruments, like MINILEVEL and LEVELTRONIC may be used. (See point 1.2. Possible configurations)**

**On one side the LEVELMETER „LIGHT“ can be used as**

- an improved version of the REMOTE DISPLAY
- and on the other hand it is
- a simplified display unit of the LEVELMETER 2000
- 

The LEVELMETER „LIGHT“ is used as a

- Display unit and also
- The interface between the measuring unit and the PC

**In contrary to the LEVELMETER 2000 the LEVELMETER „LIGHT“ does not allow to change or set parameters like e.g.:**

- - Measuring unit
- - Instrument's address / Sensor connection (Port)
- - Set up of filter parameters
- - Relative base length etc.

The LEVELMETER „LIGHT“ can be used with all the WYLER instruments based on the digital measuring cell technology. All the relevant data such as e.g.

- Calibration data
- Instrument's address
- Zero point                      etc.

are stored in the respective sensors or instruments. Through the RS 232 port the measuring data may be transmitted to a PC/Laptop or to an other outlet as well as to the measuring software LEVELSOFT of WYLER's.

The measuring principle of the digital sensor family is based on a changing of the capacity of a condenser built of two electrodes and a pendulum in form of a shield installed in between. The measured change of capacity is directly influenced by the change of the inclination of the pendulum. This capacity change is the primarily used signal for the angle to be measured. The measuring system is designed to be completely antimagnetic. The basic signal received in the LEVELMETER „LIGHT“ will be computed into an angle by comparing the signal with a reference curve stored and then displayed in the required unit.

## 1.2. Possible configurations

### A) Set-up as display unit for individual or differential measurements (similar to the use of REMOTE DISPLAY)

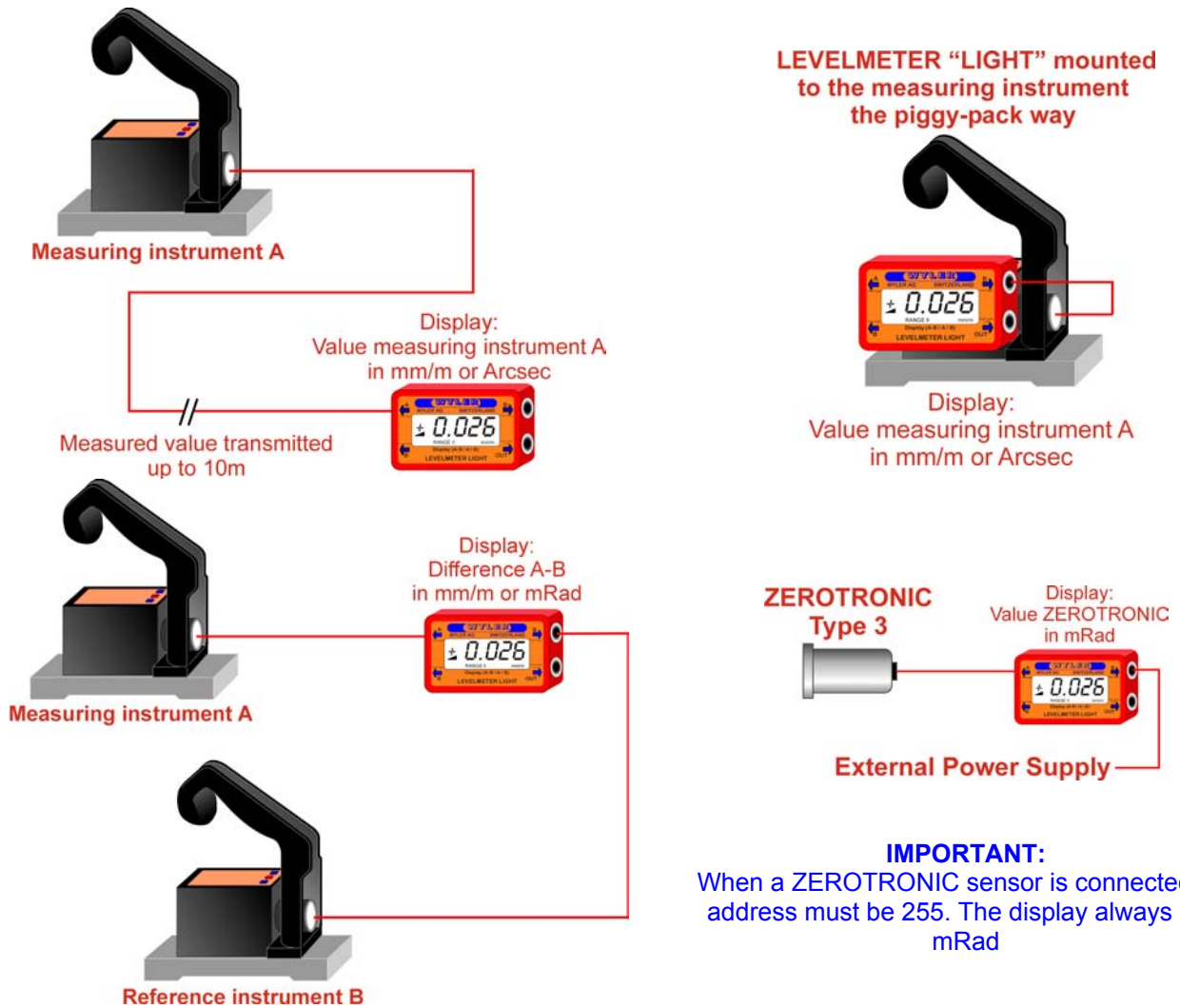

**IMPORTANT:**  
When a ZEROTRONIC sensor is connected the address must be 255. The display always is in mRad

#### Remarks:

##### Connecting instruments

- Individual units can be connected to Port „A“ or one of the Port „B“
- When differential mode is used,
  - The **Measuring instrument** must be at Port „A“ and
  - The **Reference instrument** has to be connected to one of the Port „B“

**B) Using the LEVELMETER „LIGHT“ as an alternative to the LEVELMETER 2000 together with an Engineer set no. 27 respectively with a Leveladapter set**

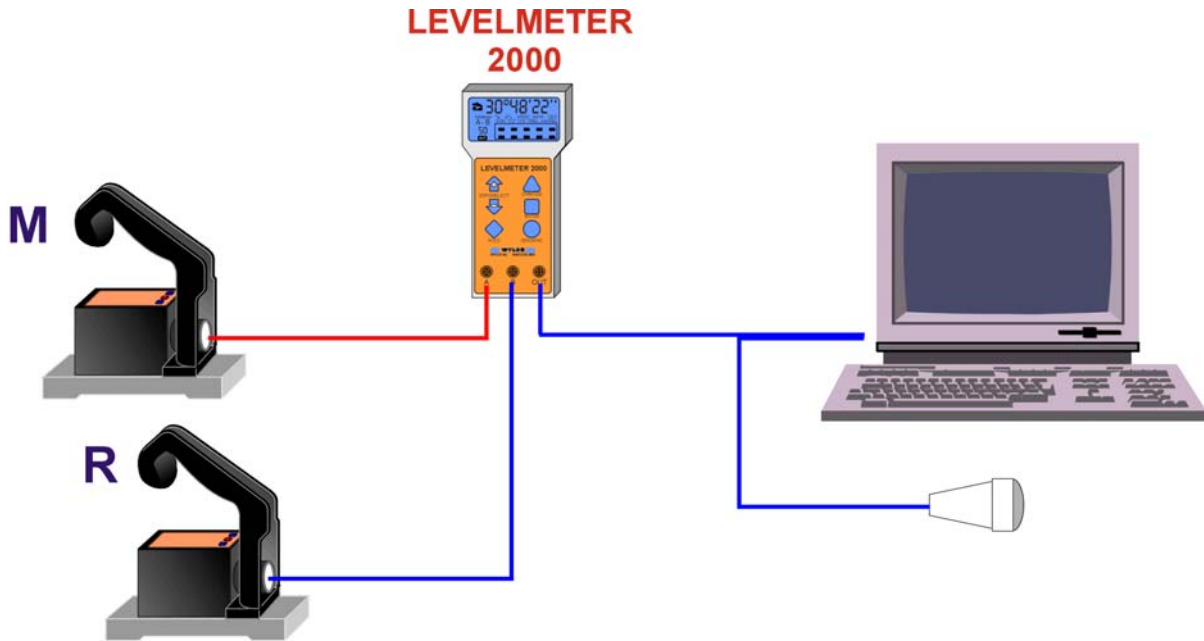

**Standard configuration of an Engineer set no. 27 with a LEVELMETER 2000**

**Positive**

- The LEVELMETER 2000 may also be used with other digital instruments and sensors
- With the LEVELMETER 2000 a number of different functions are possible, like e.g. „ZERO-SETTING“, reversal measurements, changing of units etc.

**Negative**

- The full use of the LEVELMETER 2000 features requires a minimum of training despite the fact that the handling is quite easy.
- The cost of a set as displayed above is slightly higher than with a LEVELMETER „LIGHT“

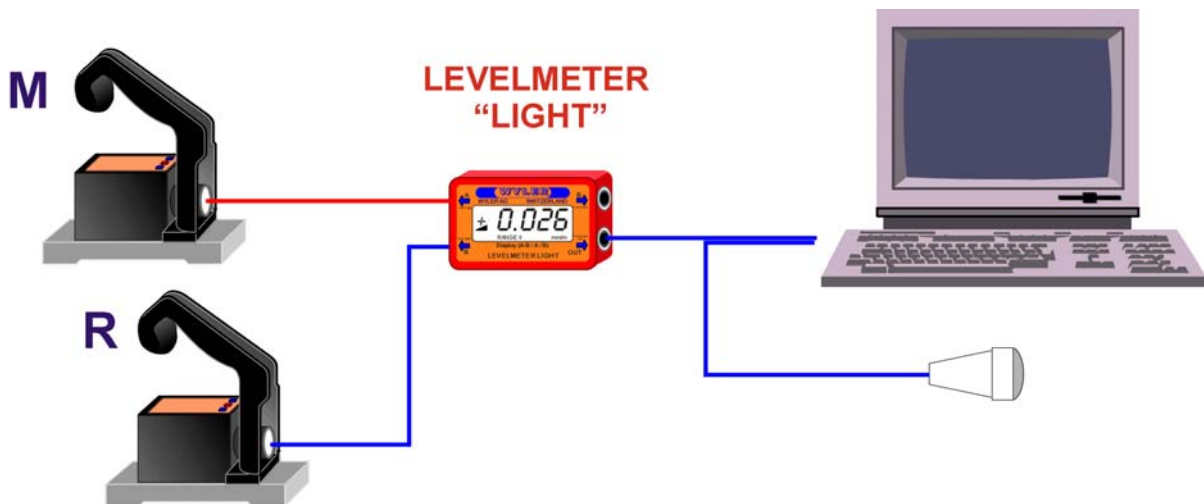

**Configuration of an Engineer set no. 27 with a LEVELMETER „LIGHT“**

**Positive**

- The use of the LEVELMETER „LIGHT“ is very easy.
- The cost of a set as displayed above are lower than with the use of a LEVELMETER 2000

**Negative**

- No additional features are available with the LEVELMETER „LIGHT“ like „ZERO SETTING“ etc.

**C) Additional possible configurations**

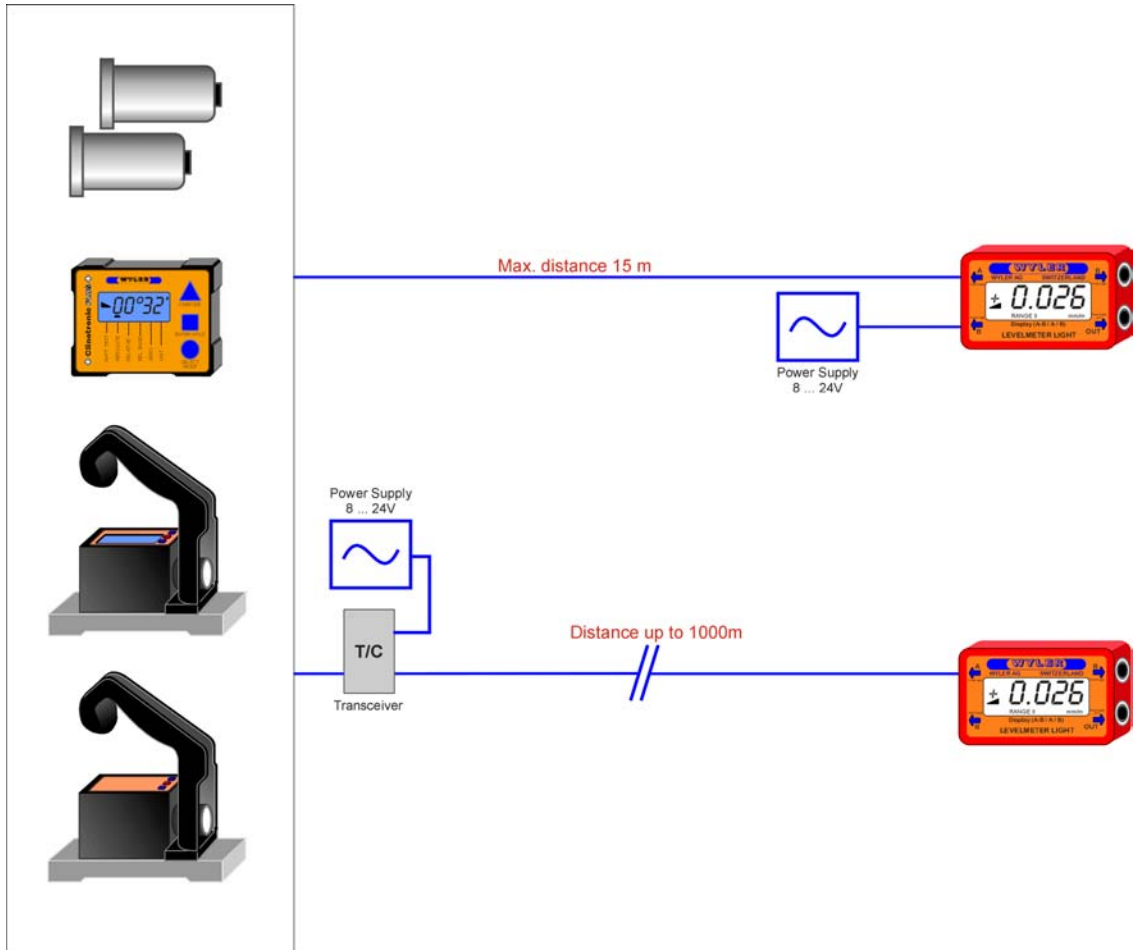

**Connecting possibilities of sensors and instruments**

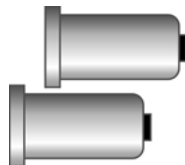

**ZEROTRONIC sensors TYPE 3**



**Inclination measuring instrument +CLINOTRONIC PLUS+**



**Inclination measuring instrument MINILEVEL NT**



**Inclination measuring instrument LEVELTRONIC NT**

**All displayed configurations are possible. Detailed information concerning specifications of the sensors and the measuring instruments are included in the respective data sheets.**

## 2. Starting

### 2.1. Short description

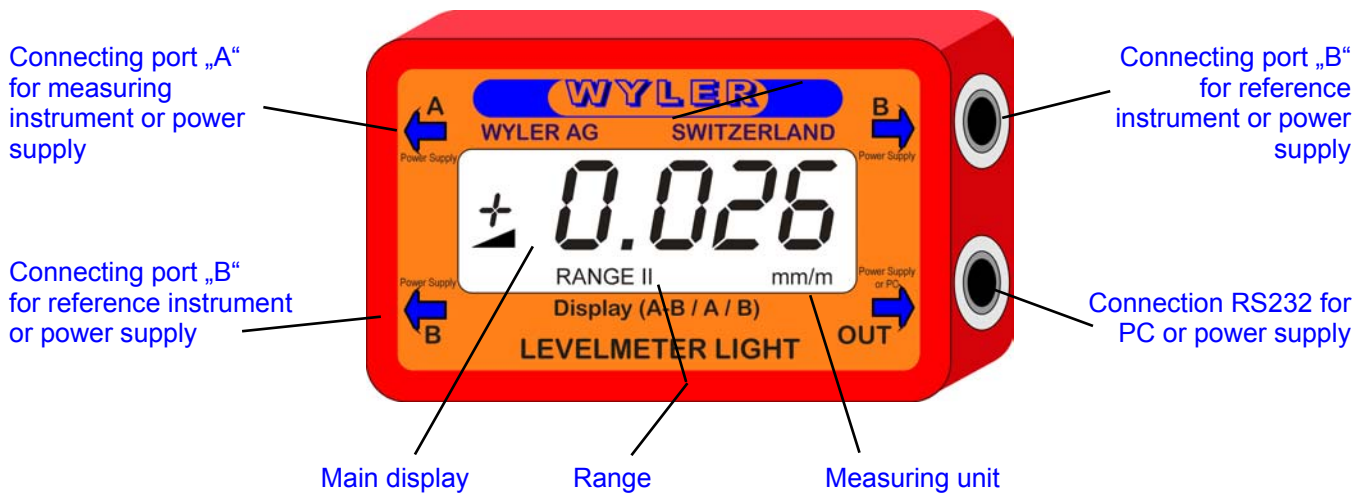

#### **IMPORTANT:**

**When during the measurement no measuring unit is displayed (no mm/m, no Arcsec) then the display is [mRad].**







### 3. How to use the LEVELMETER „LIGHT“

#### 3.1. Function check

Connect the instrument or the sensor to the LEVELMETER „LIGHT“ according to **point 1.2 „Possible configuration“**. Immediately after power is supplied **all the elements of the LCD display** are activated for a short period of time.

After a few seconds 6 small zeroes appear. This means the LEVELMETER „LIGHT“ is busy respectively calibration data is collected. After that the display shows the measured value.

#### Following display is correct:

Display	Measuring value
	-0,025 mm/m
	+20.5 Arcsec
	+0,085 mm/m <u>flashing</u> : Differential measurement [A-B]
	+0,623 mRad
	OVERRANGE in positive Range
	Levelmeter busy

#### Remarks:

1. When the symbols + or - are flashing this means the displayed value is a differential value measured between the results on Port A and Port B
2. When during a longer period of time the six small zeroes are displayed then the following causes are possible:

#### Possible causes:

- No instrument(s) or sensor(s) are connected
- Instrument(s) or sensor(s) are connected to the wrong port.
- Missing correct power supply

#### Action to be taken:

- Check configuration



## 5. REPAIR OF MEASURING INSTRUMENTS

Normally any instruments requiring repair can be sent to the local WYLER partner (local distributor) who will take the necessary steps and make the arrangements for repair on behalf of the customer.

### Express Repair Service, ERS

A large number of customers can not miss the instruments for a longer period as these are in daily operation. For these cases WYLER SWITZERLAND has created a new service called "Express Repair Service, ERS". Employing this service the transport time from the user to WYLER SWITZERLAND and back and thus the complete repair time can be reduced considerably.

A simplified description of this service:

- The customer announces the repair request to the local WYLER partner in his country.
- The WYLER partner will inform the customer about the possibility of the ERS service outlining the advantages and consequences of this service, such as e.g.
  - reduced total repair time
  - required acceptance to repair without quote up to 65 % of the price for a new instrument
  - suitable packing for air transport
  - expenses of the ERS
- In case the customer decides to use the ERS, the customer informs the local WYLER partner or directly WYLER SWITZERLAND providing the necessary data.
- The customer will receive all information and instructions necessary for a smooth handling, the customer has just to pack the product suitably and to fill in a form for the **TNT courier service** as well as to announce the readiness to the local TNT office for pick-up. Everything else will run automatically.
- Products reaching WYLER SWITZERLAND under this service will be handled with **first priority**, and the instrument will be returned using the same carrier.
- The invoicing will be through the WYLER partner in your country.

Please do not hesitate to make use of this service in order to have your WYLER instrument back at your disposal as soon as possible. In case of any questions please contact WYLER SWITZERLAND or your local distributor, we will gladly help you to use the ERS successfully.

**WYLER AG**  
Im Holderli  
CH-8405 WINTERTHUR  
Switzerland

Tel. 0041 (0) 52 233 66 66  
Fax. 0041 (0) 52 233 20 53

**Homepage:** <http://www.wylerag.com>  
**E-Mail:** [wyler@wylerag.com](mailto:wyler@wylerag.com)