

INSTRUCTIONS FOR USE



'UNIVERSEL' DIAL GAUGE



sylvac

Fabrique d'instruments de mesure de précision

*Chemin du Cloalet 16
Case Postale
1023 Crissier/Suisse*

*Tél. (021) 635 11 74
Fax (021) 634 54 71*

Contents

INSTRUCTION FOR USE FOR UNIVERSAL DIGITAL INDICATOR	5
I.1 TECHNICAL SPECIFICATIONS.....	5
II LCD DISPLAY	6
II.1 DESCRIPTION OF LCD	6
III. BUTTON FUNCTIONS	7
III.1 HOW TO USE BUTTONS.....	7
III.2 DESCRIPTION.....	7
III.3 CHANGING MODES.....	8
III.4 FUNCTION SELECTION AND ACTIVATION	8
III.5 COMBINED USE OF [MODE] AND [SET] BUTTONS.....	8
IV HOW TO OPERATE THE INSTRUMENT	8
IV.1 SWITCH ON.....	8
IV.2 SWITCH OFF.....	9
IV.3 BATTERY REPLACEMENT	9
V. DESCRIPTION OF USE.....	9
V.1 MEASURING MODES.....	9
V.1.1 Selection of unit of measurement.....	9
V.1.2 Return to zero (recall the preset).....	10
V.2 REFERENCE MODE	10
V.2.1 Selection of the reference	10
V.2.2 Hold the measure	10
V.3 INTRODUCTION OF PRESET	11
V.3.1 Selection of the digit to be modified.....	11
V.3.2 Changing the value.....	11
V.3.3 Changing the sign.....	12
V.3.4 Save the Preset value.....	12
V.3.5 Recommended use.....	12
V.4 MINMAX MODE.....	12
V.4.1 Selection of minmax mode	12
V.4.2. Selection of the functions MIN, MAX and MIN-MAX 	13
V.4.3 Resetting the MIN and MAX memory.....	13
V.5 TOLERANCE MODE.....	13
V.5.1 Introduction of tolerance values	13
V.5.1.1 Introduction of the upper limit.....	13
V.5.1.2 Introduction of the lower limit.....	14
V.5.1.3 Return to tolerance mode	14
V.5.2 Instruments with tolerance indications (diodes).....	14
V.5.2.1 How the LED are working	14
V.5.2.2 Instruments with tolerance indications (diodes).....	15
V.5.3 Hold.....	15
VI. SPECIAL FUNCTIONS	15
VI.1 DESCRIPTION.....	15
VI.2 'RADIUS/DIAMETER' FUNCTION.....	15
VI.2.1 Instrument with R/D button.....	16
VI.2.2 Instruments with 2 buttons	16
VI.2.2.1 With half duplex adapter.....	16
VI.2.2.2 Without half duplex adapter	16

VI.3	BUTTONS DISABLED.....	16
VI.3.1	Use.....	16
VI.3.2	Indication on the display.....	17
VI.3.3	How to reactivate the [mode] button.....	17
VI.3.3.1	With half duplex adapter.....	17
VI.3.3.2	Without half duplex adapter.....	17
VI.4	RESETTING THE INSTRUMENT.....	17
VII	DISPLAYED ERROR MESSAGES.....	17
VII.1	DEACTIVATE THE MESSAGE "ERROR".....	18
VIII	USE WITH HALF DUPLEX ADAPTER.....	18
VIII.1	MODES OF USE.....	18
VIII.2	HOW TO CONNECT THE OPTO-RS CABLE.....	18
VIII.3	TRANSMISSION PARAMETERS.....	18
VIII.4	USE OF THE SIMPLEX MODE, WITHOUT HALF DUPLEX ADAPTER.....	18
VIII.5	USE WITH THE HALF DUPLEX ADAPTER.....	19
VIII.5.1	Remote command names.....	19
VIII.5.2	List of remote commands.....	19
VIII.5.3	Error messages.....	21
IX.	SPECIFICATIONS.....	22
X	ACCESSORIES.....	23
XI	NOTES.....	23
XII	APPENDIX.....	23
XII.1	BATTERY REPLACEMENT.....	23
XII.2	RESETTING THE INSTRUMENT.....	23
XII.3	REFERENCE MODE.....	24
XII.4	MINMAX MODE.....	24
XII.5	TOLERANCE MODE.....	25
XII.6	CONNECTING THE OPTO-RS CABLE.....	25
XII.7	IN CASE OF PROBLEM.....	25
XII.7.1	Buttons don't work.....	26
XII.7.2	The instrument transmits continuously.....	26
XII.8	USING INT/EXT INSTRUMENTS.....	27

Instruction for use for Universal digital indicator

I.1 Technical specifications

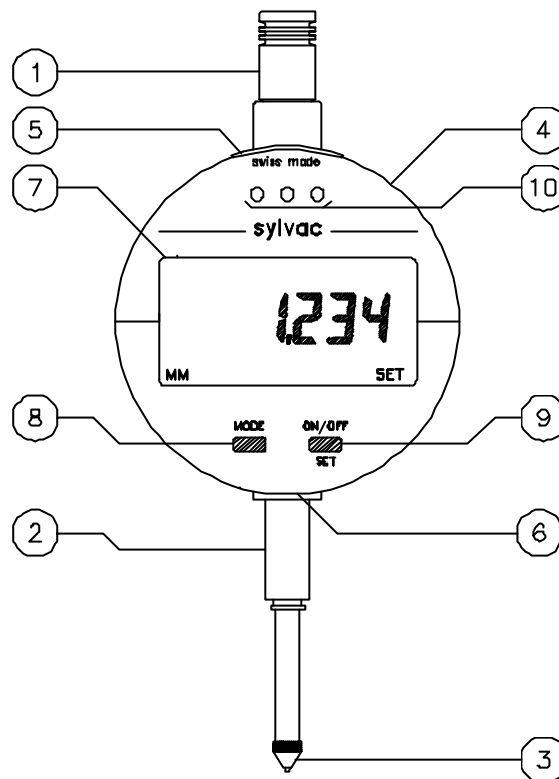

1. Interchangeable top lifting cap
2. 8 mm clamping shaft
3. Contact point, M2.5 interchangeable
4. Rotating Dial 270°
5. Cover for digital output OPTO-RS
6. Pull-out slide for battery compartment
7. Multifunctional LCD
8. [mode] button
9. [set] button (ON/OFF)
10. Indicator lamps (LEDs) for display of limits and tolerances

II LCD display

II.1 Description of LCD

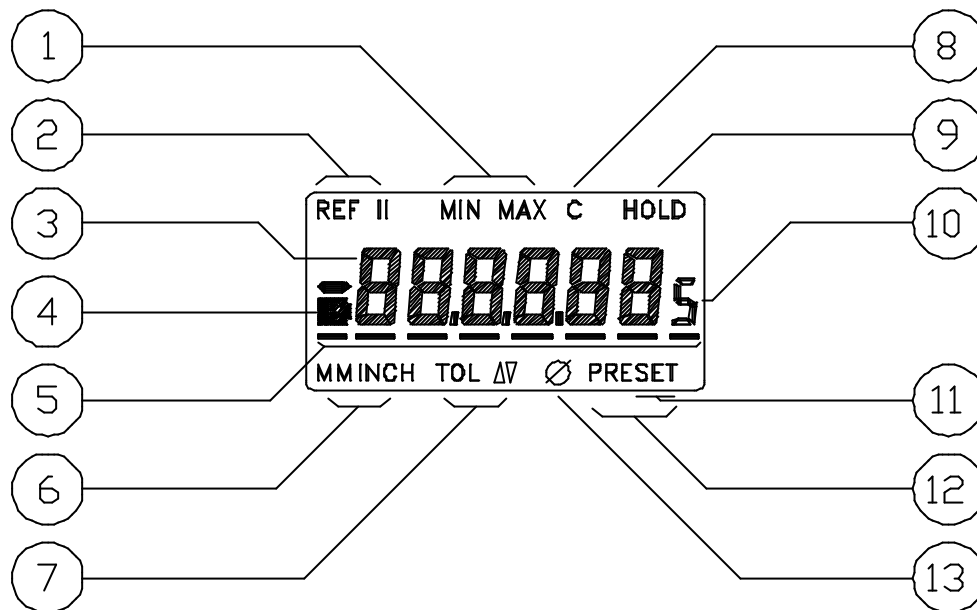

1. Indication of the minmax
2. Indication of the reference (I or II)
3. Measured value
4. Battery life warning display
5. Indicating cursor for preset tolerance
6. Indicator of the measuring unit
7. Indicator of tol mode
8. Indicator of locked mode
9. Hold indicator
10. Display .0005/.00005 inch
11. Indicator of preset / tolerances
12. Indicator of preset mode
13. Indicator of factor *2

III. Button functions

III.1 How to use buttons

Mode	MODE		SET	
	> 1sec	< 1sec	> 1sec	< 1sec
Measure		mm ↔ inch	Off	On Set
References		Ref I ↔ Ref II	Off	On Data out, hold
Preset		← 000.123 →	Incr. digit ← 0.1.2...9 →	Digit = digit + 1
Minmax		← min → max → del →	Off	On Data out + clear min or max
Tolerances		Tol	Off	On Data out, hold
Upper tol. entry		← 000.123 →	Incr. digit ← 0.1.2...9 →	Digit = digit + 1
Lower tol. entry		← 000.123 →	Incr. digit ← 0.1.2...9 →	Digit = digit + 1

MODE		SET	
> 1sec			

III.2 Description

Results when [mode] and [set] buttons are pressed less than 1 second.

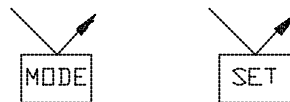

Results when [mode] and [set] buttons are pressed more than 1 second.

III.3 Changing modes

Press [mode] button until required mode is displayed.



III.4 Function selection and activation

A quick press on [mode] or [set] button will display mode position.



III.5 Combined use of [mode] and [set] buttons

Keep [mode] and [set] buttons pressed simultaneously until you get the wanted measuring direction and resolution.

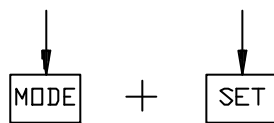

This function is not possible with 0.01mm (.0005") instrument.

IV How to operate the instrument

IV.1 Switch on

Press quickly the [set] button.

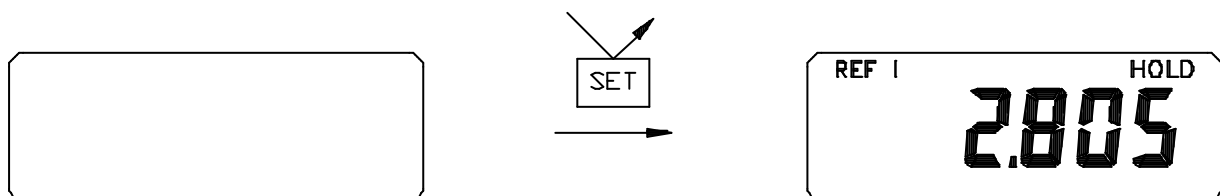

The display show the last mode setting and reading (for ex.: mode ref.).

IV.2 Switch off

Press the [set] button for 2 seconds.

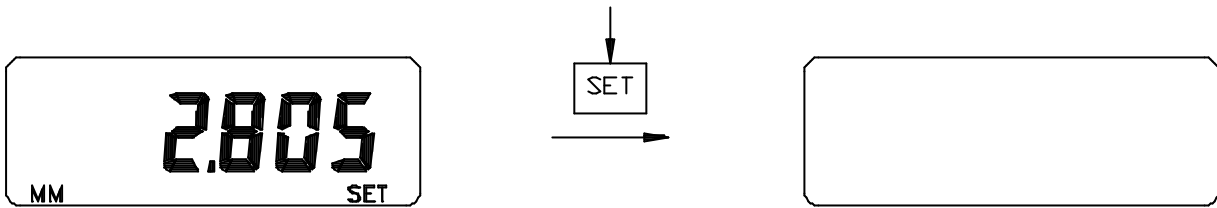

It is not possible to switch off the instrument if you are in mode for introduction of tolerances or preset.

IV.3 Battery replacement

Changing the battery is necessary when indicator 'B' is displayed. (See XII.1)

After introduction of a new battery the instrument will be in mode 'Measure' and should display 0.000 mm (0.00mm).

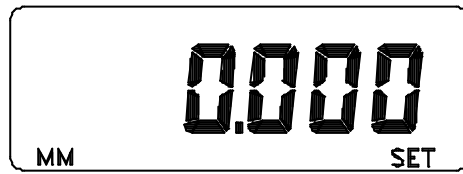

If this is not correct, proceed with setting procedure. (See XII.1)

V. Description of use

V.1 Measuring modes

V.1.1 Selection of unit of measurement

Press quickly the [mode] button to change reading mm/inch (only applicable to dual units reading instruments).

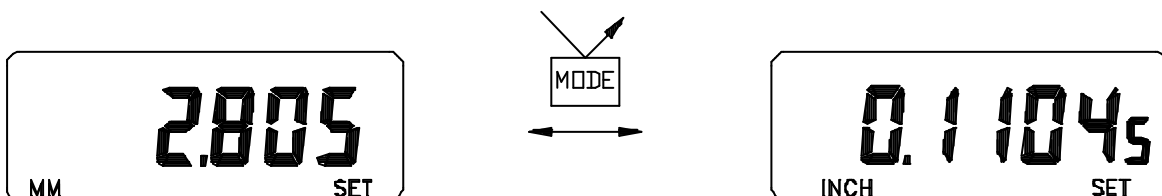

V.1.2 Return to zero (recall the preset)

Press quickly the [set] button.

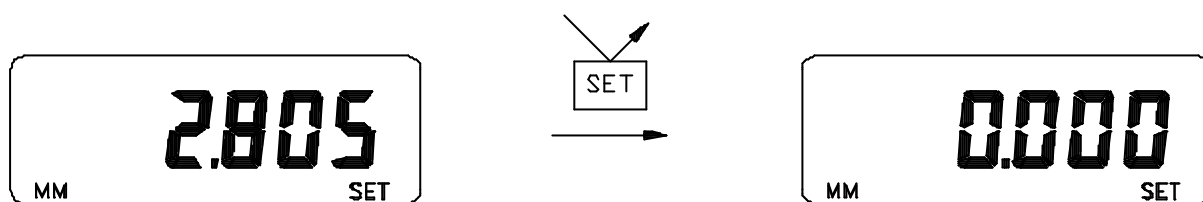

If there are no preset values introduced, the preset value is zero (here 0.000).

V.2 Reference mode

V.2.1 Selection of the reference

Press quickly the [mode] button.

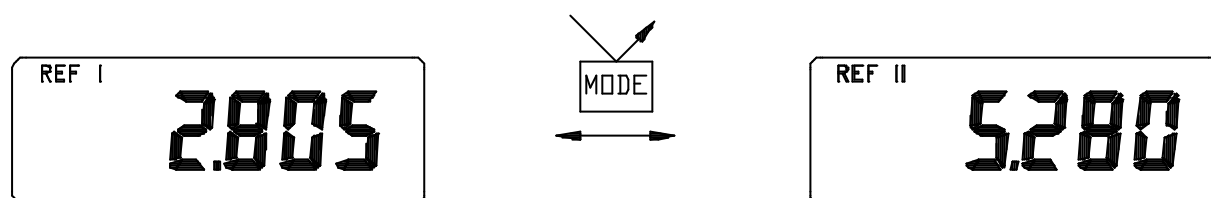

The new reference is selected.

V.2.2 Hold the measure

Press quickly the [set] button.

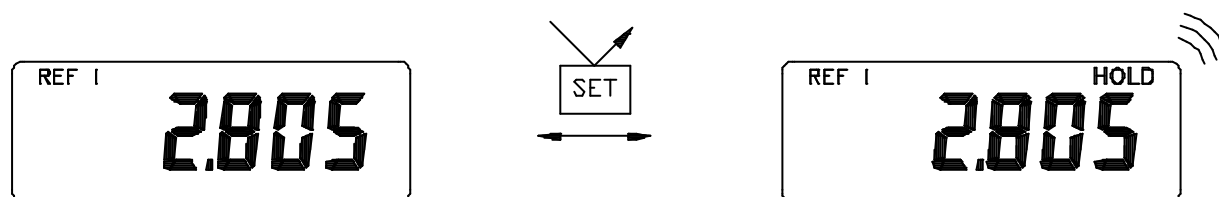

Comments: The displayed value is automatically transmitted through the interface OPTO-RS232. When no external connection is made, displayed value remains frozen. (See also instruction manual under connector OPTO-RS).

V.3 Introduction of preset

On each reference position it is possible to introduce various preset values.

- 1) Select the required reference
- 2) Select the PRESET mode (long press on [mode] button)

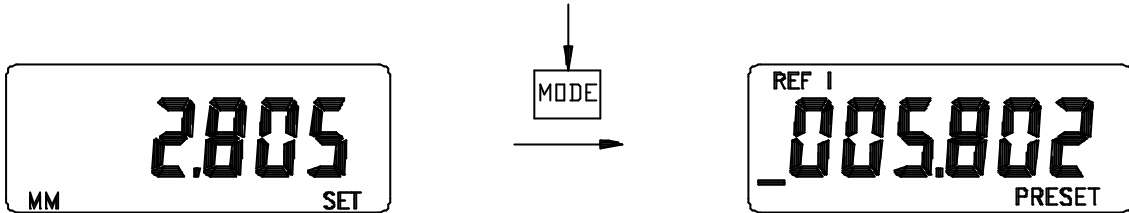

V.3.1 Selection of the digit to be modified

Press quickly the [mode] button to move the cursor.

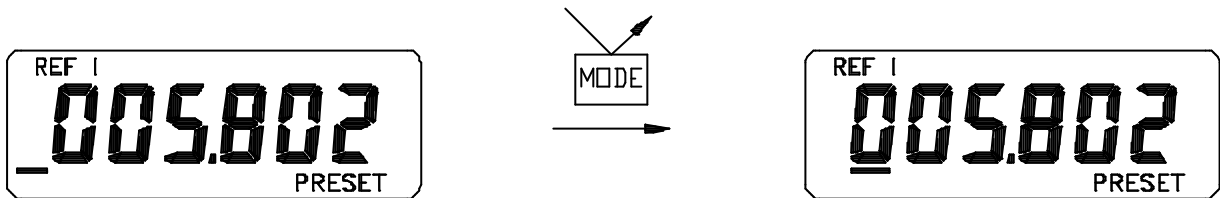

The cursor returns to the beginning (+ or - sign).

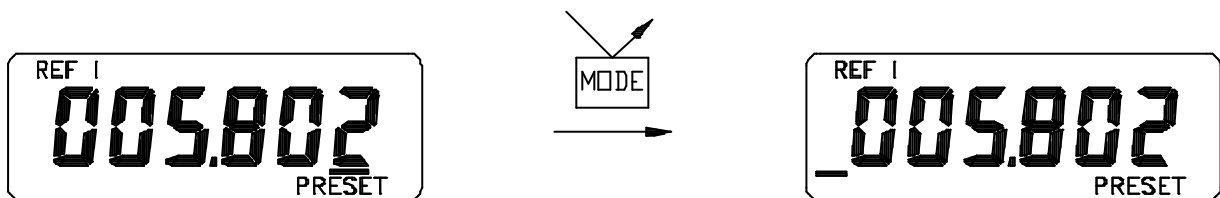

V.3.2 Changing the value

Press quickly the [set] button to increment the digit on the cursor.

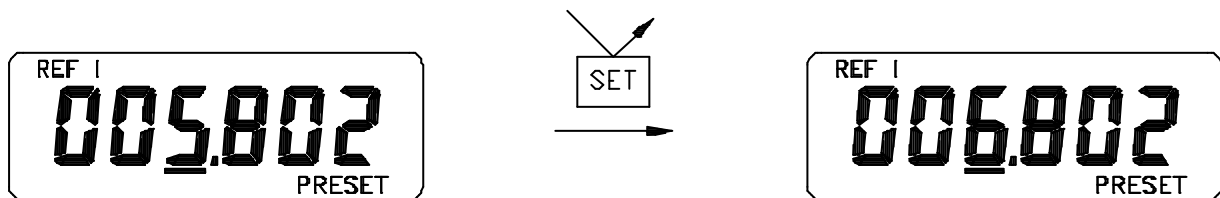

Keep [set] button pressed to increment automatically the digit on the cursor.



V.3.3 Changing the sign

Place the cursor under the sign (before the first digit), then press quickly [set] button.

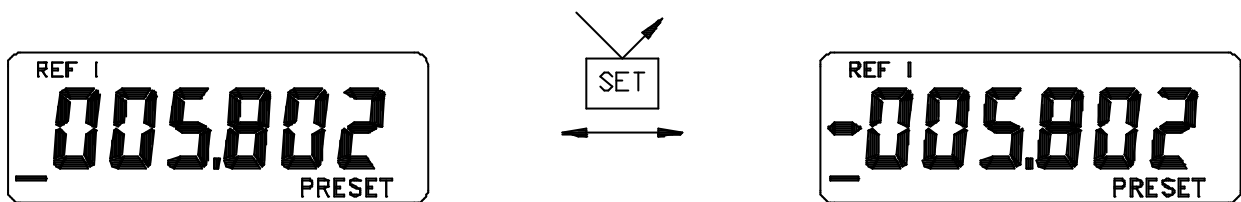

V.3.4 Save the Preset value

Keep [mode] button pressed until 'PRESET' indicator is cancelled.

V.3.5 Recommended use

Set value of preset at 0.000 mm for ref. I and use the ref. II for different preset values.

V.4 Minmax mode

For automatic storage of minimum (or maximum) value in dynamic measurement.

V.4.1 Selection of minmax mode

Keep [mode] button pressed until 'MIN' is displayed.

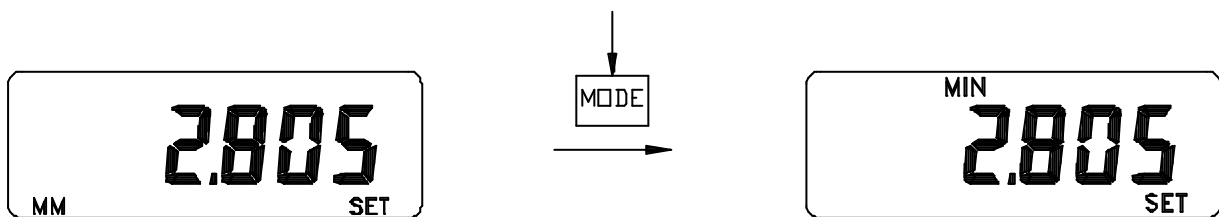

The instrument selects the function used before leaving this mode (MIN, MAX or |MIN-MAX|). All previous storages of that mode are deleted and the display shows the current value.

V.4.2. Selection of the functions MIN, MAX and |MIN-MAX|

Press quickly the [mode] button to change the function.



V.4.3 Resetting the MIN and MAX memory

Press quickly the [set] button to clear MIN or MAX displayed values. The displayed value is now the current value.



Remarks:

- in mode |MIN-MAX| the values MIN and MAX are activated
- prior to clearing the MIN or MAX values, signals are transmitted via OPTO-RS interface for processing.

V.5 Tolerance mode

In the tolerance mode, the arrows indicate that the measured value shown is outside the preset tolerances (rework or reject). If no arrow is displayed, measured value is within (good).

V.5.1 Introduction of tolerance values

V.5.1.1 Introduction of the upper limit

Keep [mode] button pressed until tolerance mode is displayed.

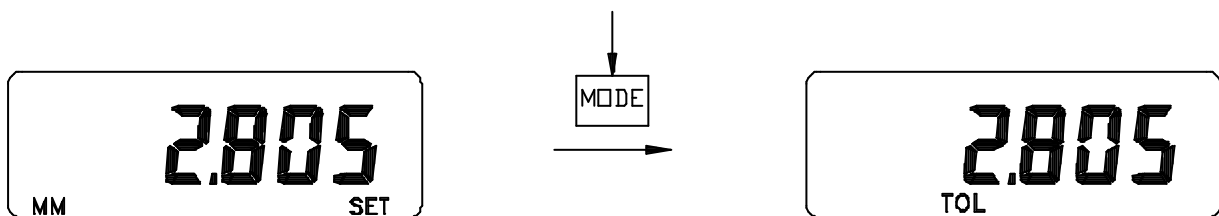

Press quickly the [mode] button to introduce upper tolerance limit.

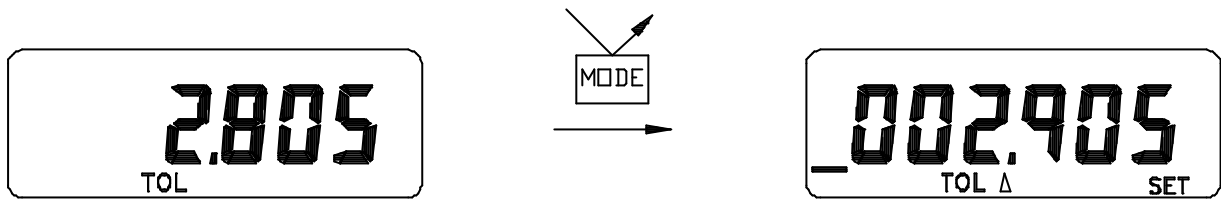

Refer to chapter V.3 (Introduction of preset value) to introduce the upper tolerance limit.

V.5.1.2 Introduction of the lower limit

Keep [mode] button pressed until lower tolerance limit is displayed.

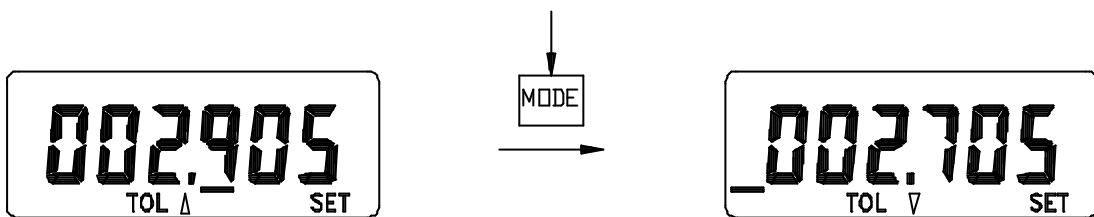

Refer to chapter V.3 for introduction of lower tolerance limit (i.e. preset values).

V.5.1.3 Return to tolerance mode

Keep [mode] button pressed until set indicator is cancelled.

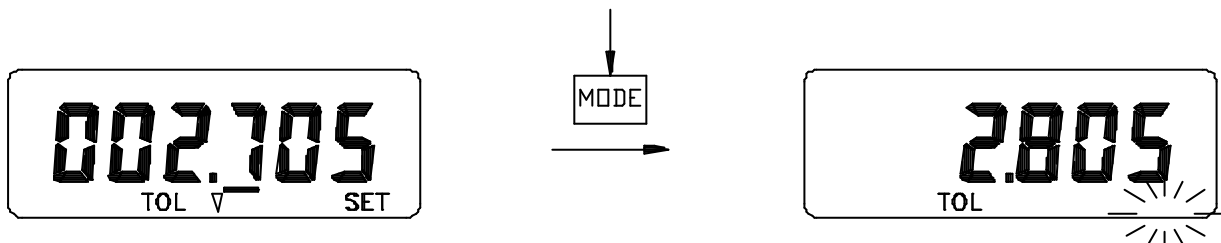

V.5.2 Instruments with tolerance indications (diodes)

The preset tolerance limits will be the references for activating the LED.

V.5.2.1 How the LED are working

The LED will be activated for 5 sec. as soon as the measured value is stable.
This system allows to extend the battery life.

V.5.2.2 Instruments with tolerance indications (diodes)

The lights display the condition of the measured component:

- red is reject
- green is good
- yellow is rework

For internal measurements the red and yellow light are to be reversed (reject is over upper limit). It may be necessary to invert the action of the light signals according to the measuring mode (internal and depth measurements).

In this case the introduction of the limits has to be reversed. (Introduce the lower limit instead of the upper limit).

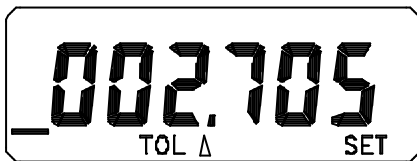

V.5.3 Hold

Press quickly the [set] button.

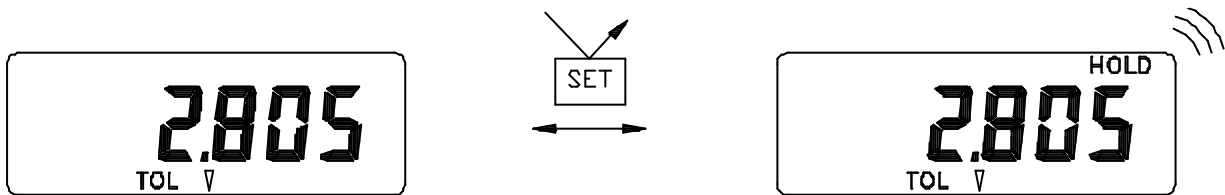

Note: If the instrument is connected to a computer or printer using RS232 output, pressing the [set] button causes a data transmission.

Without cable connection, pressing the [set] button will freeze the displayed value (see also OPTO-RS instruction of use).

VI. Special functions

VI.1 Description

These functions are active for all these mode operations: measurement, references, minmax, tolerances.

They can be activated by remote command (with additional OPTO-RS half duplex adapter) or with the R/D button for instruments with 3 buttons.

VI.2 'Radius/diameter' function

This button allows a multiplication factor of *1 (for radius) or *2 (for diameter).

VI.2.1 Instrument with R/D button

Press 'R/D' button longer than 1 second to switch between 'radius' and 'diameter' mode.

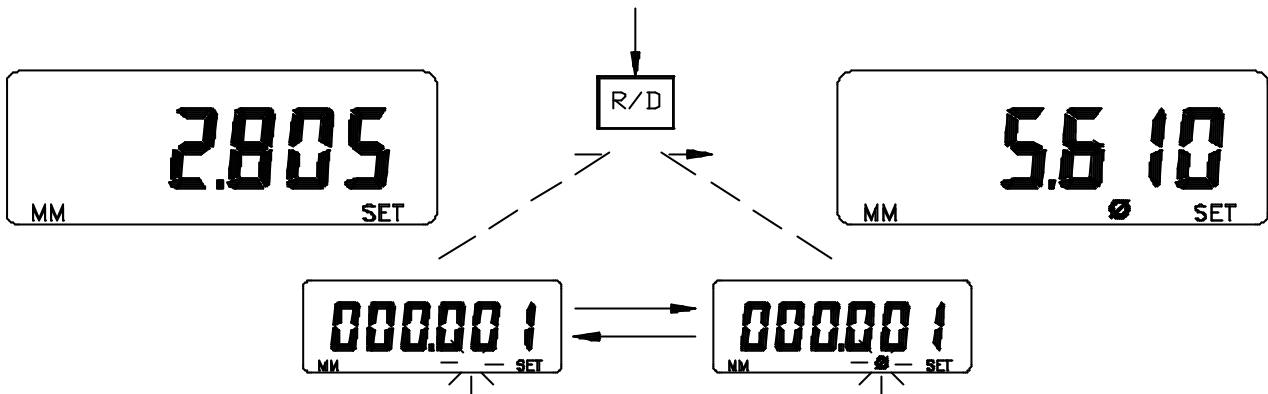

VI.2.2 Instruments with 2 buttons

VI.2.2.1 With half duplex adapter

Add the half duplex adapter to the OPTO-RS cable.

Refer to the OPTO-RS manual and use command CHA*1, CHA*2 (see VIII Use with half duplex adapter).

VI.2.2.2 Without half duplex adapter

Activate the function 'diameter' is not possible without the use of peripheral equipment. A reset will deactivate it, but all the introduced parameters will be lost (Refer to chapter XII).

Remove the battery for at least 30 seconds to reset the instrument to the factory default condition.

VI.3 Buttons disabled

VI.3.1 Use

Deactivate the [mode] button to prevent accidental modifications of the instrument set-up. The [set] button remains active.

VI.3.2 Indication on the display

The symbol 'C' on the display indicates the [mode] button is disabled.

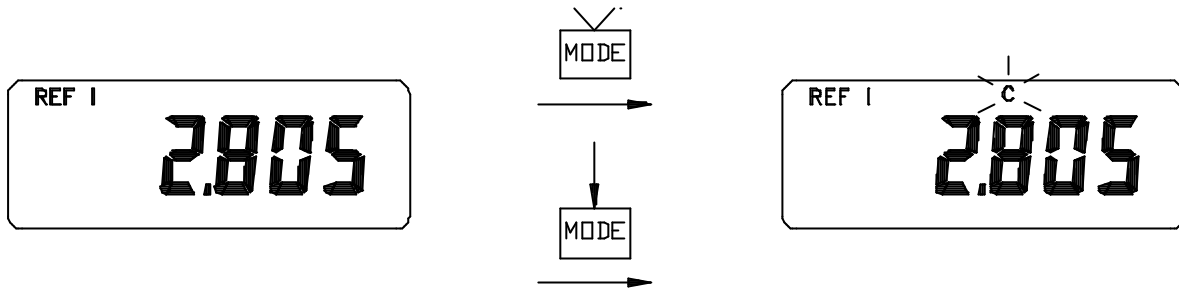

VI.3.3 How to reactivate the [mode] button

VI.3.3.1 With half duplex adapter

Using the half duplex adapter, use the remote command <KEY1> (see VIII.5.1 and the OPTO-RS instructions for use).

VI.3.3.2 Without half duplex adapter

Activate the function 'keyboard lock' is not possible without the use of peripheral equipment. A reset will deactivate it, but all the introduced parameters will be lost (Refer to chapter XII).

VI.4 Resetting the instrument

In case of electronic problem, resetting the instrument is advised.

The basic parameters will be reactivated. All the other parameters will be lost. This function can also be used to deactivate any mode previously activated by retro-command. Refer to chapter XII.

VII Displayed error messages

In case errors are detected during the measurement, the instrument displays the message "error" and outputs the message <ERRO>.

VII.1 Deactivate the message "Error"

Press [set] to restart the measurement.

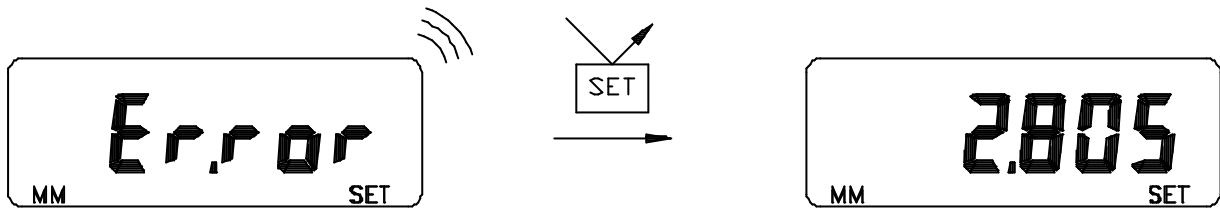

Don't forget to check the instrument's origin.

VIII Use with half duplex adapter

VIII.1 Modes of use

Simplex mode: enables the instrument to be polled from the computer (i.e. footswitch or request by periphery).

Duplex mode: enables the instrument to be polled by the computer and provides for 2 way communication to allow use of the instrument transmit button. The instrument and other half duplex devices cannot receive and transmit data simultaneously.

VIII.2 How to connect the OPTO-RS cable

Check the way you plug the connector in.

If you plug it wrong, no damage will result but it simply won't work.

VIII.3 Transmission parameters

4800 Bauds, even parity, 7 ASCII bits, 2 stop bits

VIII.4 Use of the simplex mode, without half duplex adapter

The data output can be initiated by quick press on the [set] button in the following modes:

- references
- minmax
- tolerances

The data output can be requested from the computer by toggling the DTR line in the following modes:

- **measuring**
- **references**
- **minmax**
- **tolerances**

See also user manual of OPTO-RS.

VIII.5 Use with the half duplex adapter

With the half duplex adapter, you may completely control the instrument from the computer by sending remote commands in the following modes

- **measuring**
- **references**
- **minmax**
- **tolerances**

See OPTO-RS user manual for connexion on a computer

VIII.5.1 Remote command names

Most commands consist of 3 characters followed by either a 0 or 1 (disabled or enabled). Note: commands may be upper or lower case and should be followed by the ASCII code <CR>. The instrument echoes the command.

VIII.5.2 List of remote commands

<NOR>

Will set the instrument in the measure mode (or in reference mode if the button is disabled)

<MOD?>

The instrument returns its current mode of operation (NOR, REF, MIN,MAX, DEL, TOL1)

<STO0>, <STO1>

Deactivates or activates the measurement "HOLD"

<KEY0>, <KEY1>

Deactivates or activates [mode] button

<RST>

Reset the instrument to the factory default condition

<SET?>

The instrument returns its current parameters (MM RES2 REF1 etc)

Note:

- B1 Battery OK
- B0 Battery must be replaced

<ID?>

The instrument returns its class identification

- SY210A: instrument basic
- SY210B: instrument complete with preset, minmax, tol. mode.

<OUT0>, <OUT1>

Deactivates or activates continuous data output.

<OFF>

Turns off the instrument

<ON>

Turns on the instrument

<PRI>, <?>

The instrument returns the displayed value.

Remark: if tolerances mode is active, ASCII code '<', '=' or '>' is added.

<CHA+>, <CHA->

Changes the measuring direction

<CHA?>

The instrument returns the active measuring direction.

<CHA*1>, <CHA*2>

Changes the multiplication factor

<MM>, <IN>

Changes the measurement unit

<RES2>, <RES3>

Changes the resolution:

-<RES2>: 0.001 mm
.00005 "

-<RES3>: 0.01 mm
0005 "

<REF1>, <REF2>

Changes the reference

<PRE>

Recalls the last preset value

<PRE?>

The instrument returns the last preset value

<TOL1>

Activates the tolerance mode

<TOL?>

The instrument returns the tolerance limit values

**<MIN>, <MAX>, **

DEL = Delta = [MAX-MIN] Selection of the dynamic mode

<CLE>

Resets the MIN, MAX memory

<PRE + 123.45>**<PRE + 0>**

Presets the display to the required value.

Note: don't forget to use the correct sign preceding the value

<TOL +12.54 +11.25>

Sets the tolerance limits

VIII.5.3 Error messages

In case of error, the instrument displays following messages:

<ERR0>

Refers to a system error. To escape press [set] button or use remote command to retake measurement.

<ERR1>

Transmission problem

If error is repeated, check the transmission parameters.

<ERR2>

Syntax error: command not recognised.

IX. Specifications

Range (Depending on gauge): 0-12.5mm / .5 "
.....	0 - 25 mm / 1"
Resolution: 0.001 mm / .00005" (0.01mm / .0005")
Accuracy: 5µm or .0002" (10 µm or .0004")
Repeatability: 2 µm or .0001" (+/-2s)
Maximum operation speed: 1.5 m/sec / 60"per sec.
Measuring force: 0.6 to 1.1 N for 0-25 mm (0-1")
.....	0.7 to 0.95 N for 0-12.5 mm (0-.5")
Measuring units: metric or imperial (direct conversion)
Measuring system: Sylvac system (patented)
Display: LCD, sign (-), 6 digits (7 in "), size 8.5 mm (.05 mil in)
.....	In imperial half size least significant digit, measuring
.....	unit and mode is displayed
Power: 1 lithium battery 3 V type CR2032, capacity 190 mAh
Battery types: Toshiba CR2032/BR2032
.....	Maxell CR2032/BR2032
.....	Renata B/CR2032/BR2032
.....	Sanyo CR2032/BR2032
.....	Ucar CR2032/BR2032
.....	Panasonic CR2032/BR2032
.....	Rayovac CR2032/BR2032
.....	Varta CR2032 /BR2032.
Power consumption: 80 µA
Battery life: 1 year with normal use, 2000 work hours per year.
.....	When "B" is displayed, the remaining battery life is
.....	slightly more than 1 day.
.....	(To protect our environment, please recycle the
.....	battery)
Working temperature: +5 to +40° C / +41 to +104° F
Output: direct RS232
Interface: RS232 compatible interface cable with opto-electronic
.....	coupler.
Construction: - aluminium case
.....	- polyamid rotating dial 270° (gauge dependant)
.....	- measuring spindle hardened and ground stainless
.....	steel
Clamping: metric 8 h6
.....	imperial 3/8" (optional)
Contact point: metric M2.5 (or imperial 4-48" optional)
.....	interchangeable
Protection according to IEC 529: IP 51
Weight: 130 g or 4.6 ounces

X Accessories

RS232 optocoupled cable, 2m length with DB-9F connector	926.5521
RS232 optocoupled cable, 2m length without connector	926.5522
RS232 optocoupled cable, 2m length with Hirose connector for EDP5000H printer	926.5523
Adaptor 9p M/ 9p M for D100/D80	926.5524
Adaptor Simplex-Duplex (9p M/ 9p F, foot pedal entry) for OPTO-RS	926.5537
OPTO-RS software support disk (3 ½")	981.7130
OPTO-RS software support disk (5 ¼")	981.7131

XI Notes

- The top lifting cap as well as the contact point must be hand-tightened only .
- Opening the gauge (dial side) voids the warranty.
- The instrument accuracy and other specifications are only guaranteed when the instrument is tested at 20°C (68°F) mounted vertically and clamped by its stem.

XII Appendix

XII.1 Battery replacement

Remove the battery housing and replace the battery insuring the proper polarity.

XII.2 Resetting the instrument

Changing the battery will automatically reset the instrument.
Remove the battery for approx. 30 sec. before replacing it again.

XII.3 Reference mode

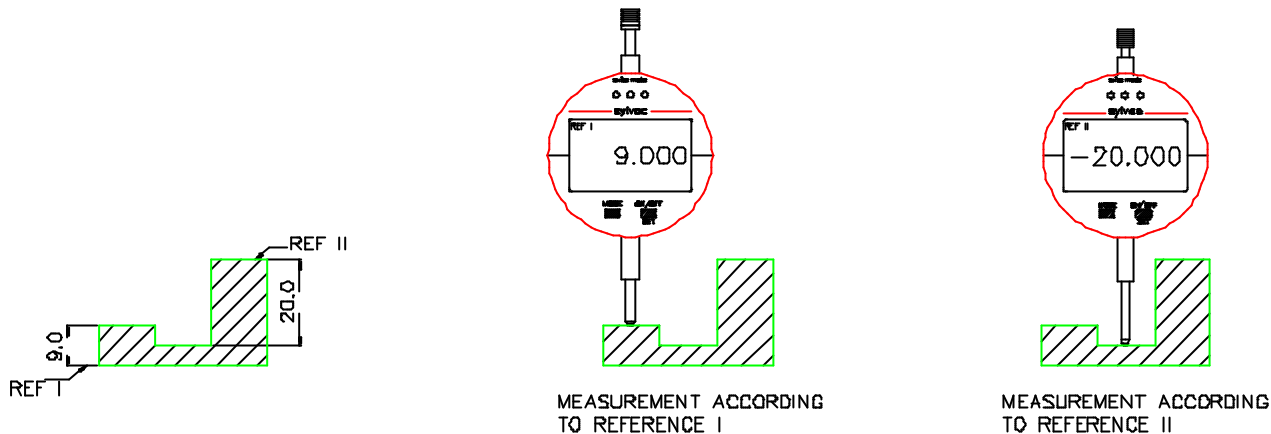

XII.4 Minmax mode

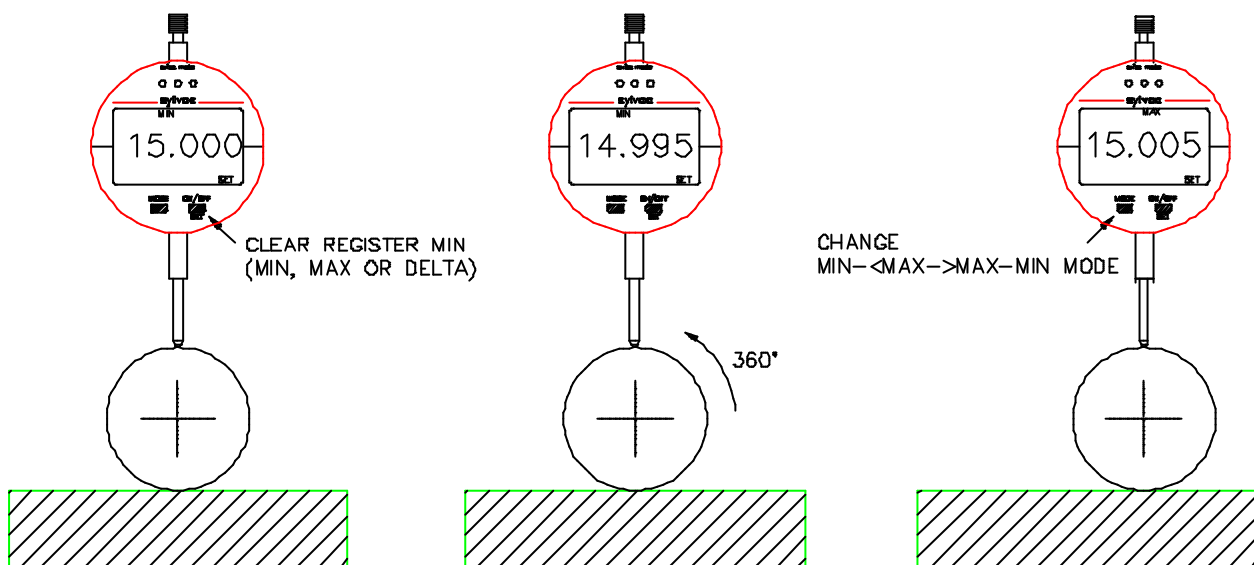

XII.5 Tolerance mode

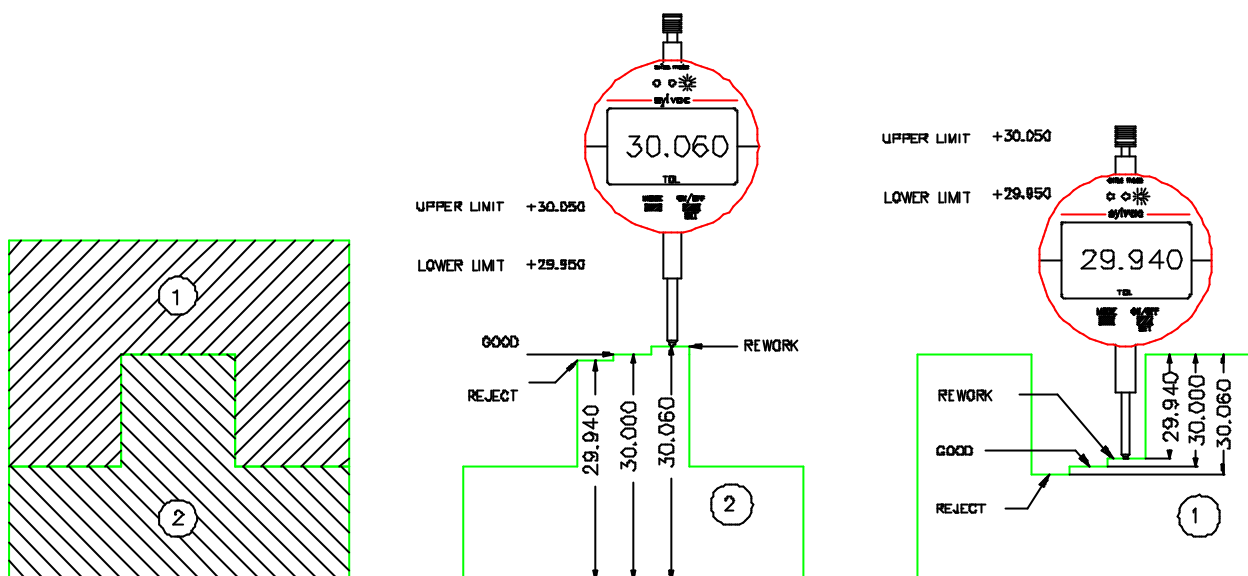

XII.6 Connecting the OPTO-RS cable

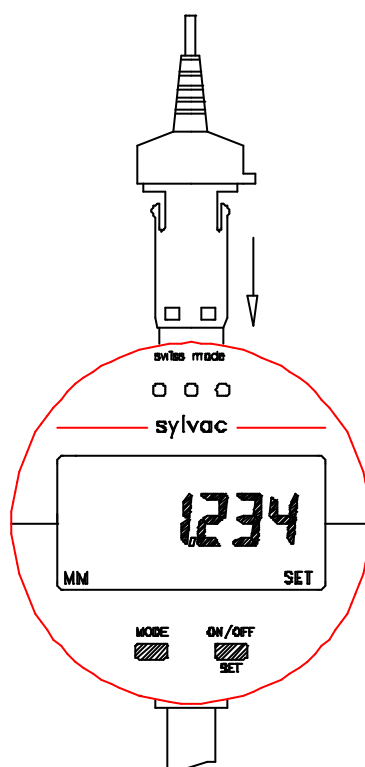

XII.7 In case of problem

In case of wrong function of the instrument, remove the battery at least 30 seconds to reset.

XII.7.1 Buttons don't work

Check first if the buttons are locked ('C' will appear on the display pushing [mode] button).
If 'C' appears, send <KEY1> to the instrument or reset it (see XII.2).

If the instrument is connected to a peripheral equipment requesting continuously the data, the buttons are not working, the priority is given to the OPTO-RS transmission.
Stopping the request will make the buttons work again.

XII.7.2 The instrument transmits continuously

The transmission mode <OUT1> is being active.

Deactivate this mode transmitting <OUT0>.

If the peripheral equipment can't transmit data (i.e. printer), reset the instrument (see XII.2)



① ENTER RING VALUE AS PRESET

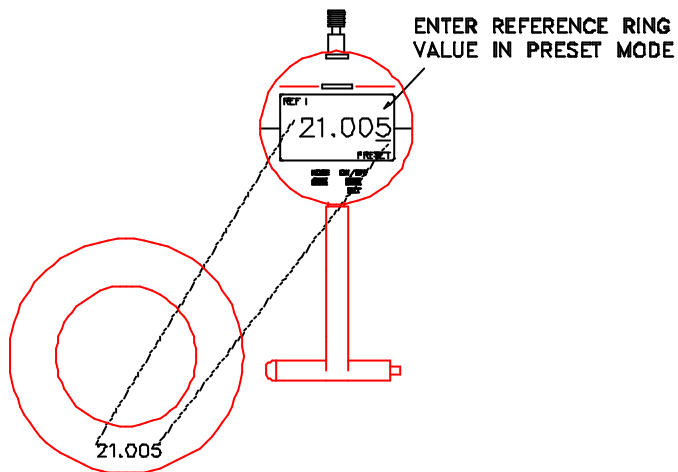

② SELECT MINMAX MODE FOR CALIBRATION

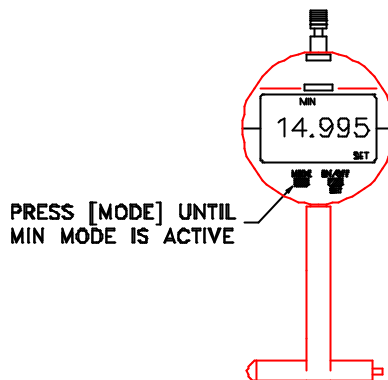

③ PREPARE THE GAUGE TO MEASURE THE RING

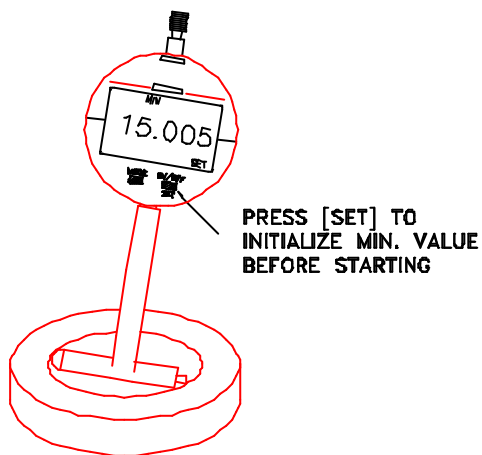

④ MEASURING THE MIN VALUE OF THE RING

MOVE SLOWLY THE GAUGE FROM ONE SIDE TO THE OTHER TO FIND THE MINIMUM VALUE OF THE RING. (AUTOMATIC STORAGE OF MIN. VALUE)

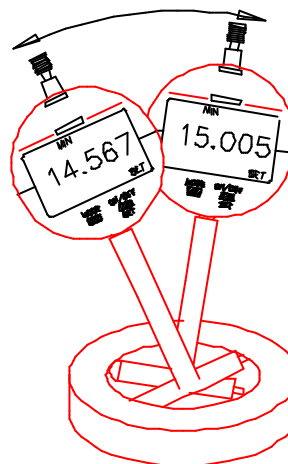

⑤ MIN VALUE IS OK

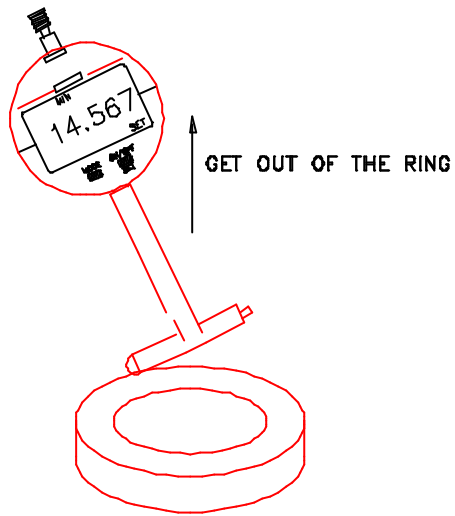

⑥ PREPARE TO CALIBRATE THE GAUGE AT RING VALUE

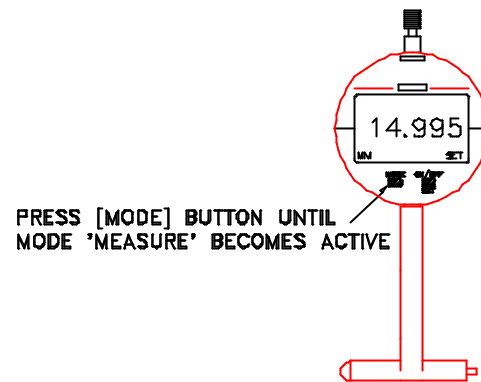

⑦ SET PRESET VALUE AS REFERENCE

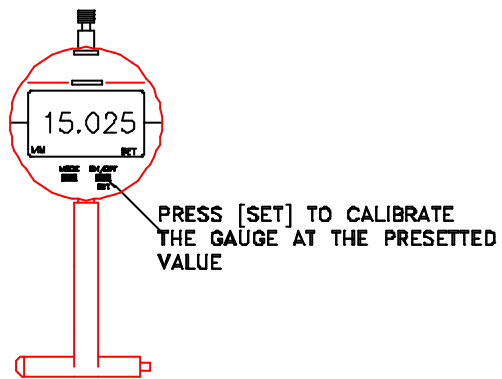

⑧ PREPARE TO MEASURE

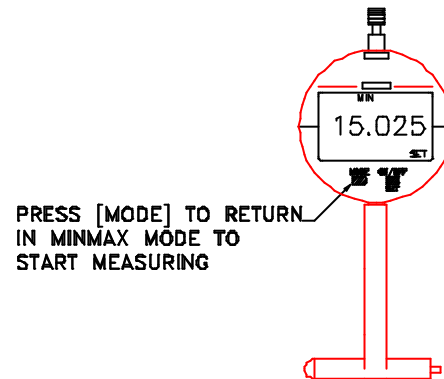

REMARK:
USE THE GAUGE AS IN POINTS 2, 3 AND 4 TO MEASURE
(USE 'MEASURE' MODE ONLY FOR CALIBRATION)